

MicroCal iTC₂₀₀ System

MicroCal Auto-iTC₂₀₀ System

MicroCal iTC₂₀₀ and MicroCal Auto-iTC₂₀₀ isothermal titration calorimetry (ITC) instruments (Fig 1) allow direct and label-free measurement of binding affinity and thermodynamics. Heat released or absorbed during biochemical binding events is measured directly, giving information about relative binding affinity (K_D), stoichiometry (n), enthalpy (ΔH), and entropy (ΔS). This information provides valuable insights into the mechanism of binding, including hydrogen bonding, van der Waals interactions, and hydrophobic interactions. MicroCal iTC₂₀₀ is the calorimeter core for the fully automated MicroCal Auto-iTC₂₀₀, which is designed to address the needs of drug discovery and development scientists by combining the performance of MicroCal iTC₂₀₀ with full automation for unattended operation.

MicroCal iTC₂₀₀ and MicroCal Auto-iTC₂₀₀ provide:

- Complete thermodynamic profile in a single experiment
- Direct measurements of binding specificity and stoichiometry
- Homogeneous, solution-based assays, which allow interaction studies of binding partners in their native state
- Minimal assay development
- Possibility to apply to a variety of biomolecular interactions with no molecular weight limitations

System design and description

MicroCal iTC₂₀₀ and MicroCal Auto-iTC₂₀₀, isothermal titration calorimeters from GE Healthcare, provide detailed insight into binding energetics. These systems have a low-volume 200 μ l sample cell and as little as 10 μ g of sample is required to obtain a complete thermodynamic signature.



Fig 1. MicroCal iTC₂₀₀ (left) and MicroCal Auto-iTC₂₀₀ (right).

The system measures heat evolved or absorbed directly in liquid samples as a result of mixing precise amounts of reactants.

The miniaturized sample cell design provides short equilibration times and a throughput rate of a sample every 25 min. Little if any assay development is needed. MicroCal iTC₂₀₀ can be easily upgraded to the fully automated MicroCal Auto-iTC₂₀₀ as throughput needs grow.

A schematic drawing of MicroCal iTC₂₀₀ instrument is shown in Figure 2. The sample and reference cells are made from Hastelloy™ alloy, which is a nonreactive material. Cells are fixed-in-place providing reproducible, ultrasensitive performance with low maintenance requirements. Sample and reference cells are accessible for filling through the top of the unit. An integrated wash module facilitates thorough cleaning of the sample cell. Access stems lead from the top exterior of the instrument to the 200 μ l coin-shaped cells.

The sample delivery system is computer-controlled to ensure accurate and reproducible injections. There are three user-selectable titration response times for application flexibility, and variable mixing speed to match sample conditions. The sample compartment is Peltier-controlled for rapid thermal equilibration; the operating range is 2°C to 80°C.



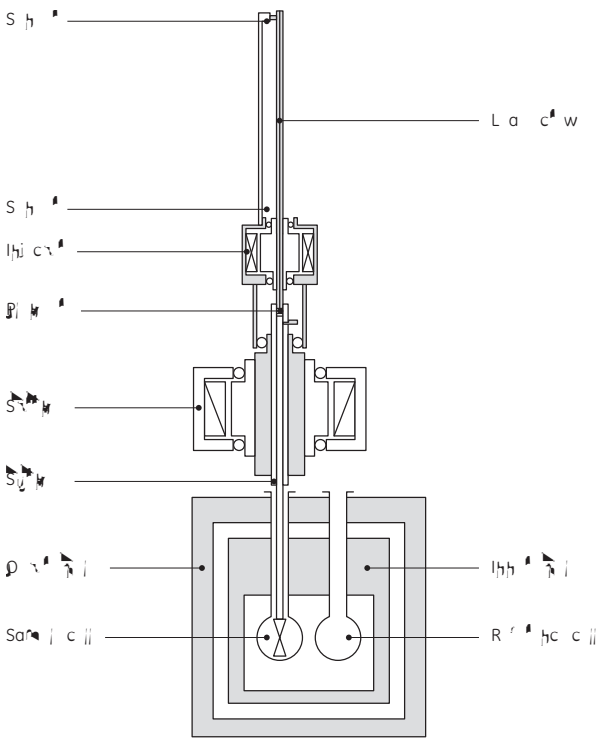

Fig 2. Schematic drawing of MicroCal iTC₂₀₀.

With MicroCal Auto-iTC₂₀₀, all filling, injection, and cell-cleaning functions are fully automated, controlled, and operated through software that includes integrated experiment design wizards to assist in selecting experimental parameters.

Data analysis is performed with Origin® software using fitting models to calculate reaction stoichiometry (*n*), binding constant (*K_D*), enthalpy (ΔH), and entropy (ΔS), and the results are presented in Microsoft™ Excel™ format for further analysis or data transfer.

The ITC experiment

ITC measures the heat absorbed or generated when molecules interact. These heat changes are small, typically submillionths of a degree, but are universal and can be detected by these very sensitive instruments.

A solution of the biomolecule is first placed in the sample cell and a ligand solution in a matching buffer is placed in the syringe (Fig 3A). When the ligand solution is injected into the cell, the ITC instrument detects heat that is released or absorbed as a result of the interaction. This is done by measuring the changes in the power needed to maintain isothermal conditions between the reference and the sample cell. Injections are performed repeatedly, and result in peaks that become smaller as the biomolecule becomes saturated. Eventually, the peak sizes remain constant and represent only the heats of dilution.

Once titration is completed, the individual peaks are integrated by the instrument software (Fig 3B) and presented in a Wiseman plot (Fig 3C). An appropriate binding model is chosen and the isotherm is fitted to yield the binding enthalpy ΔH , the *K_D*, and the stoichiometry, *n*. From these data, Gibbs' free energy, ΔG and entropy, ΔS are calculated.

Besides confirming direct interactions with the target of interest, thermodynamic measurements also provide insight into the nature of the noncovalent forces responsible for binding. Polar interactions tend to contribute favorably to the enthalpic component, whereas entropically favored interactions tend to be more hydrophobic. Figure 4 shows representative ITC binding isotherms for two interactions with the same affinity but with different mechanisms of binding.

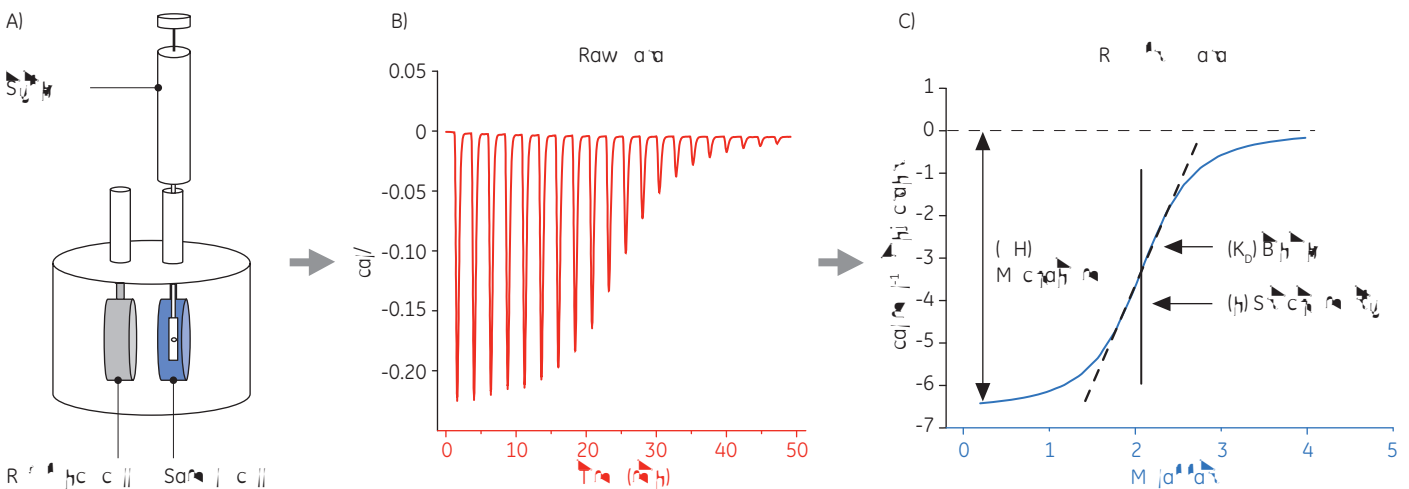

Fig 3. (A) The ligand is titrated into the sample cell. (B) An exothermic reaction releases heat and gives negative peaks. (C) The peaks are integrated and presented in a Wiseman plot.

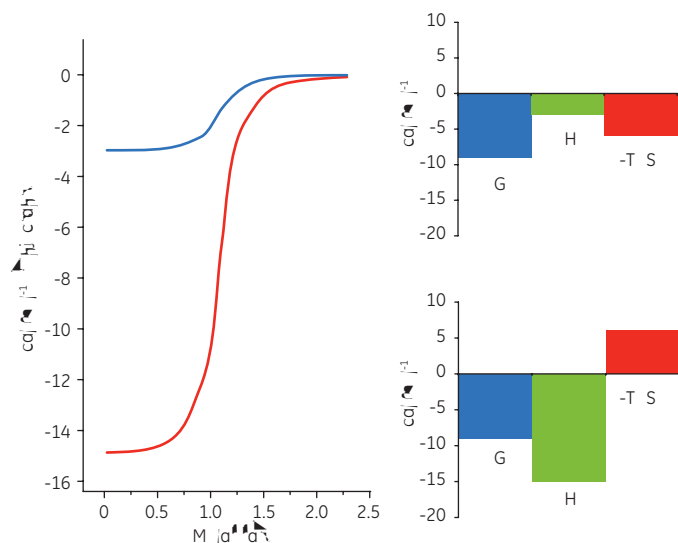

Fig 4. An entropy-driven interaction (blue curve and top right profile) tends to be more hydrophobic in character compared to an enthalpy-driven interaction (red curve and bottom right profile), which tends to be driven by hydrogen-bonding and van der Waals interactions.

Elucidation of reaction mechanisms

To demonstrate how ITC can be used not only to measure binding affinity but also provide insight into the mechanism of binding, the interaction of peptides with the protein target Bcl-2 (name derived from B-cell lymphoma 2) has been studied with MicroCal iTC₂₀₀.

Experiments were carried out at 25°C. The sample cell was filled with Bcl-2 (30 μM solution) in 50 mM HEPES, pH 7.4, 100 mM NaCl, 0.5mM TCEP, and 5% DMSO. The peptides were diluted to a concentration of 250 μM in the same buffer. The injection volumes were 3 μl each, injection time 6 s, and a 150 s delay between each injection. The results are shown in Figure 5.

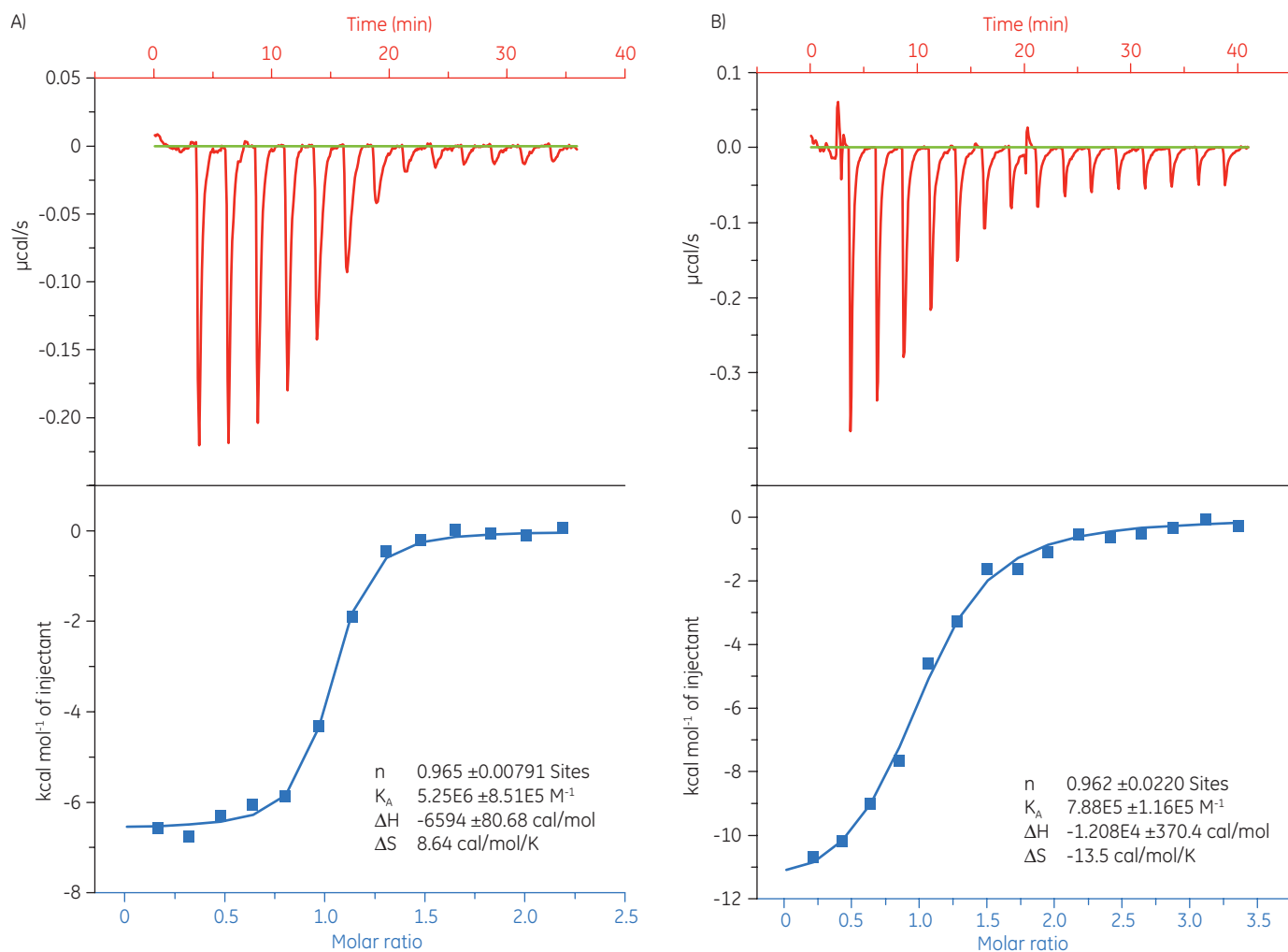

Fig 5. The top panels show the raw data. The bottom panels show the binding isotherms created by plotting the integrated heat peaks against the molar ratio of the peptide. (A) Injection of BAD-like peptide. (B) Injection of BAX peptide.

The binding affinity of the BAD-like (Bcl-2-associated death promoter) peptide for Bcl-2 protein is approximately six-fold stronger than that of the BAX (Bcl-2-associated X protein) peptide. Visualization of thermodynamic parameters in the form of a binding signature plot (Fig 6) makes it easier to see how the enthalpic and entropic components contribute to the overall affinity, represented here by ΔG . These plots reveal that the binding of the BAD-like peptide to Bcl-2 is comprised of hydrogen bonding and hydrophobic interactions as indicated by the negative or favorable binding enthalpy (ΔH) and entropy factor ($T\Delta S$), while the binding of BAX involves more conformational changes as indicated by the unfavorable entropy in addition to hydrogen bonding (ΔH).

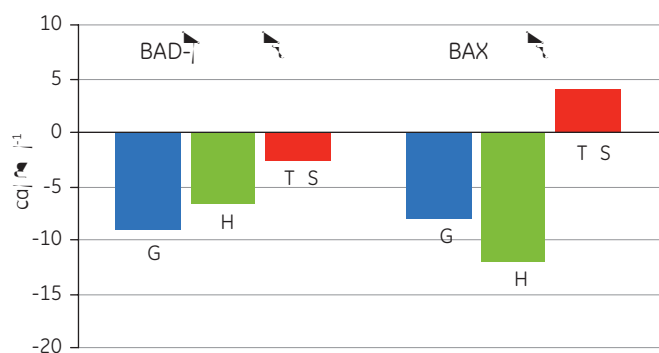

Fig 6. The binding signature (free energy, binding enthalpy, and entropy factor) plotted for the two binding events.

Simultaneous determination of thermodynamic parameters

To study the interaction of carbonic anhydrase with five known inhibitors, a series of 20 runs was performed using a MicroCal Auto-iTC₂₀₀ (Table 1). The workflow, including sample introduction, titration, and cleaning was completely automated. Each inhibitor was run four times and all 20 runs were completed in 15 h. The excellent reproducibility of the replicate injections is demonstrated in the overlaid binding isotherms (Fig 7).

Both CBS and furosemide have similar binding affinities, yet different enthalpies, suggesting that the binding mechanisms are different.

Table 1. Thermodynamic parameters determined for the interaction of five inhibitors with bovine carbonic anhydrase II (BCA). The values are the average of four separate runs with errors shown

Ligand/ Concentration	BCA (μM)	n	K_D (μM)	ΔG (kcal mol^{-1})	ΔH (kcal mol^{-1})	$-T\Delta S$ (kcal mol^{-1})
Acetazolamide/ 0.126 mM	10	0.98 ± 0.02	0.06	-9.87	-11.15 ± 0.46	1.28
CBS/ 0.414 mM	30	1.00 ± 0.04	0.96	-8.21	-10.19 ± 0.12	1.98
Furosemide/ 0.426 mM	30	0.98 ± 0.08	0.92	-8.23	-7.06 ± 0.20	-1.17
Sulfanilimide/ 0.441 mM	30	0.99 ± 0.05	4	-7.35	-7.93 ± 0.39	0.58
TFMSA/ 0.525 mM	30	1.03 ± 0.02	0.35	-8.8	-2.03 ± 0.07	-6.77

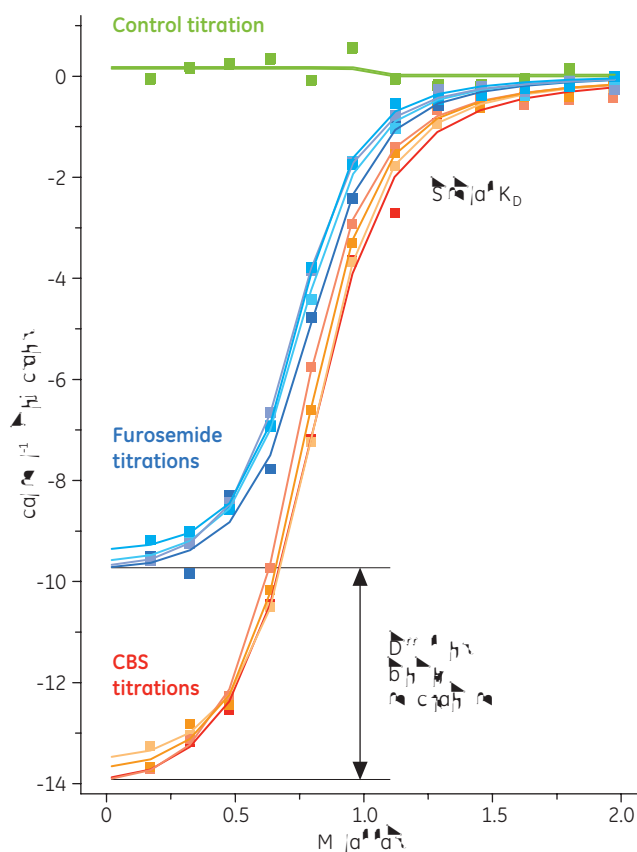

Fig 7. Overlay plots from four repeated titrations of bovine carbonic anhydrase II, with CBS (left) and furosemide (right).

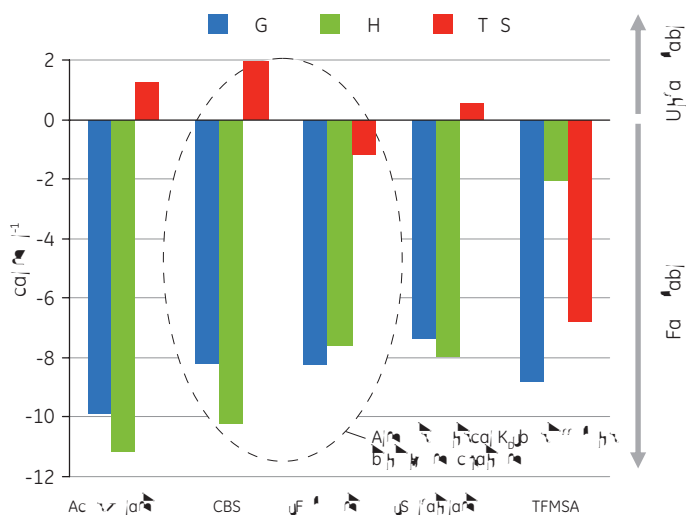

Fig 8. Binding signatures for five inhibitors of bovine carbonic anhydrase II.

The binding signatures for these interactions are shown in Figure 8. From the enthalpy and unfavorable entropy factor, CBS has binding based entirely on hydrogen and van der Waals bonds with some conformational changes reducing the affinity. Furosemide has a more balanced binding based on hydrogen and van der Waals bonds as well as hydrophobic effects. This illustrates that even when the inhibitors have almost identical binding affinities, important differences in binding mechanisms can be easily determined.

Verify hits through increased understanding of binding mechanisms

It is important to rule out false positives from a primary screening at an early stage. ITC can provide such information, saving considerable time and effort later on. A 20 μM solution of target protein (TP) was loaded into the sample cell of MicroCal iTC₂₀₀ and titrated with Compound X (Fig 9). The K_D was determined to 4.9 μM , which correlated well with studies performed with Biacore™ systems and NMR, thus confirming that Compound X is suitable for further studies.

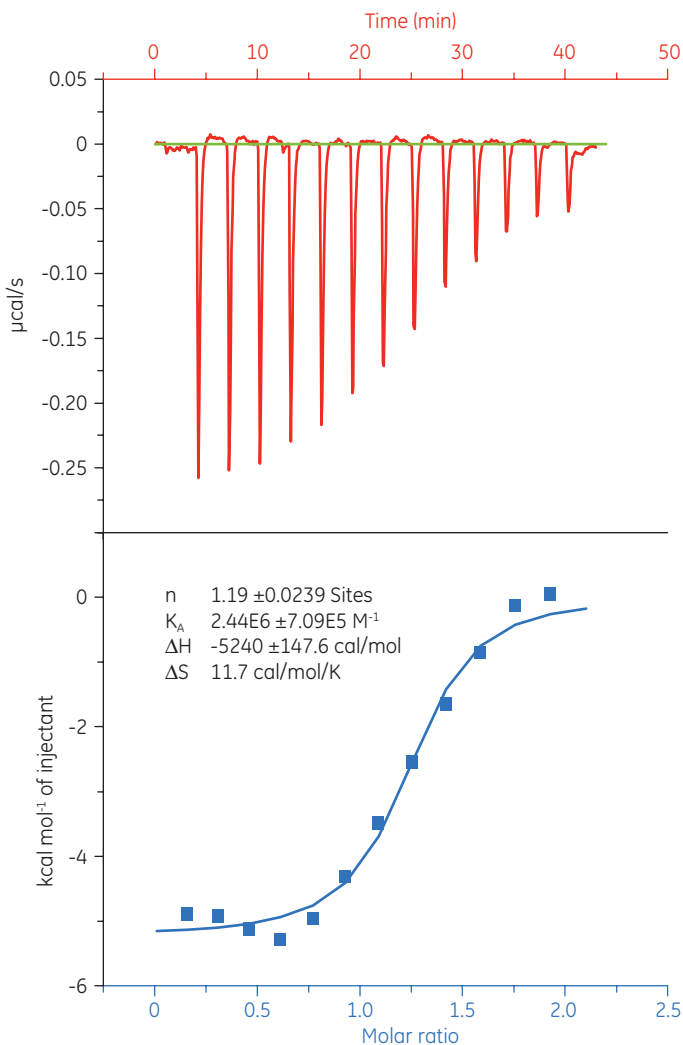

Fig 9. Raw data and binding isotherm for the interaction of Compound X with TP, data show a reversible binding.

When the same target solution was titrated with Compound Y, the results were very different (Fig 10). In the left panel, Compound Y was titrated with TP. The isotherm shows a binding affinity of 120 nM, but the binding enthalpy was about 1000-fold larger than expected and the stoichiometry value (0.01) very low. In the right panel, the same drug candidate was titrated with bovine serum albumin (BSA). Taken together, the results indicate nonspecific activity and this compound is not suitable for further development. Based on these experiments, Compound Y was considered to be a false positive and was rejected for further study.

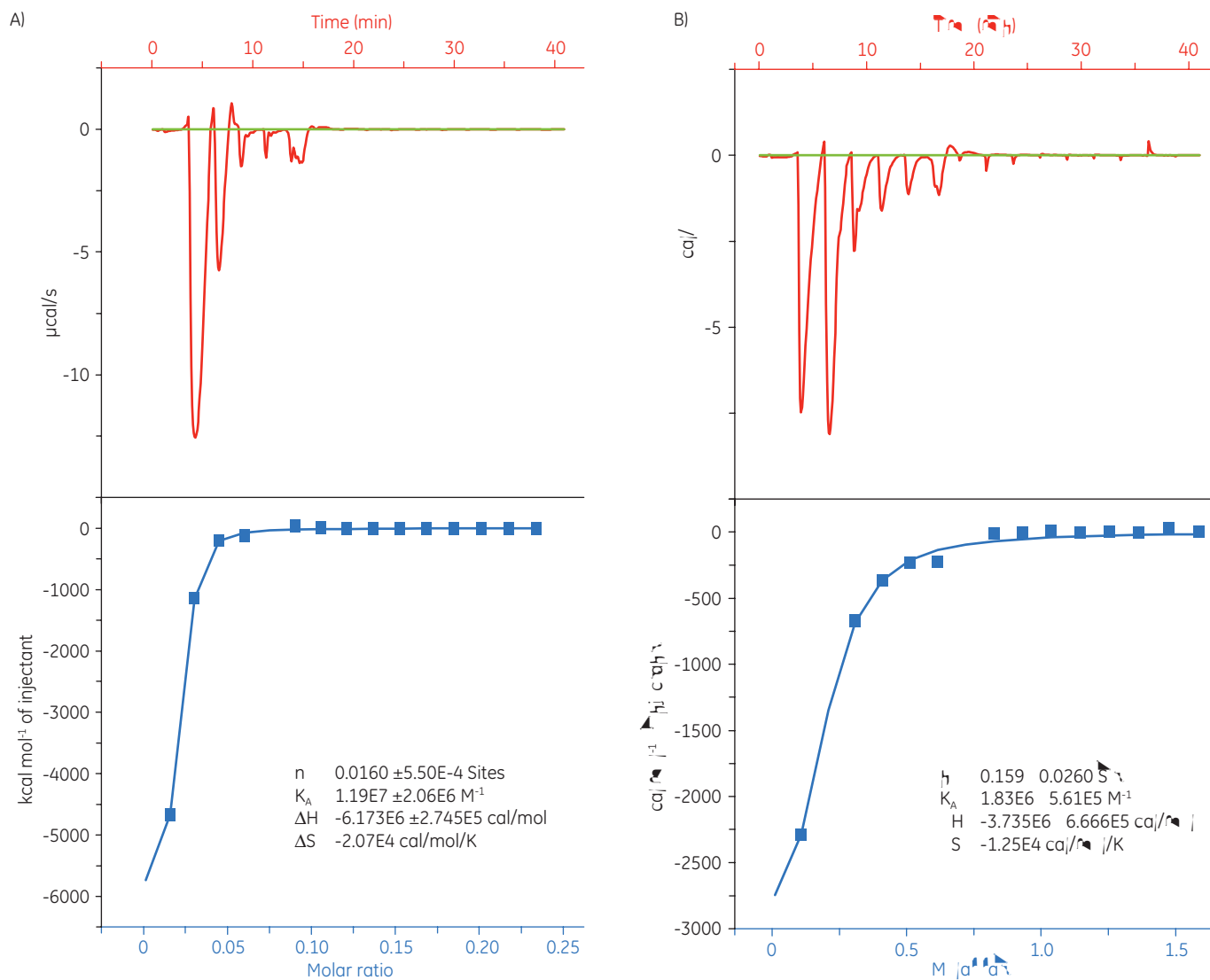

Fig 10. Data for an irreversible interaction of Compound Y with TP (left) and nonspecific binding to BSA (right).

Assessing protein quality

ITC can be used to assess the activity level of a target protein before use in high throughput screening. Two batches of a target protein were compared using MicroCal iTC₂₀₀ by titration with a standard peptide (Fig 11).

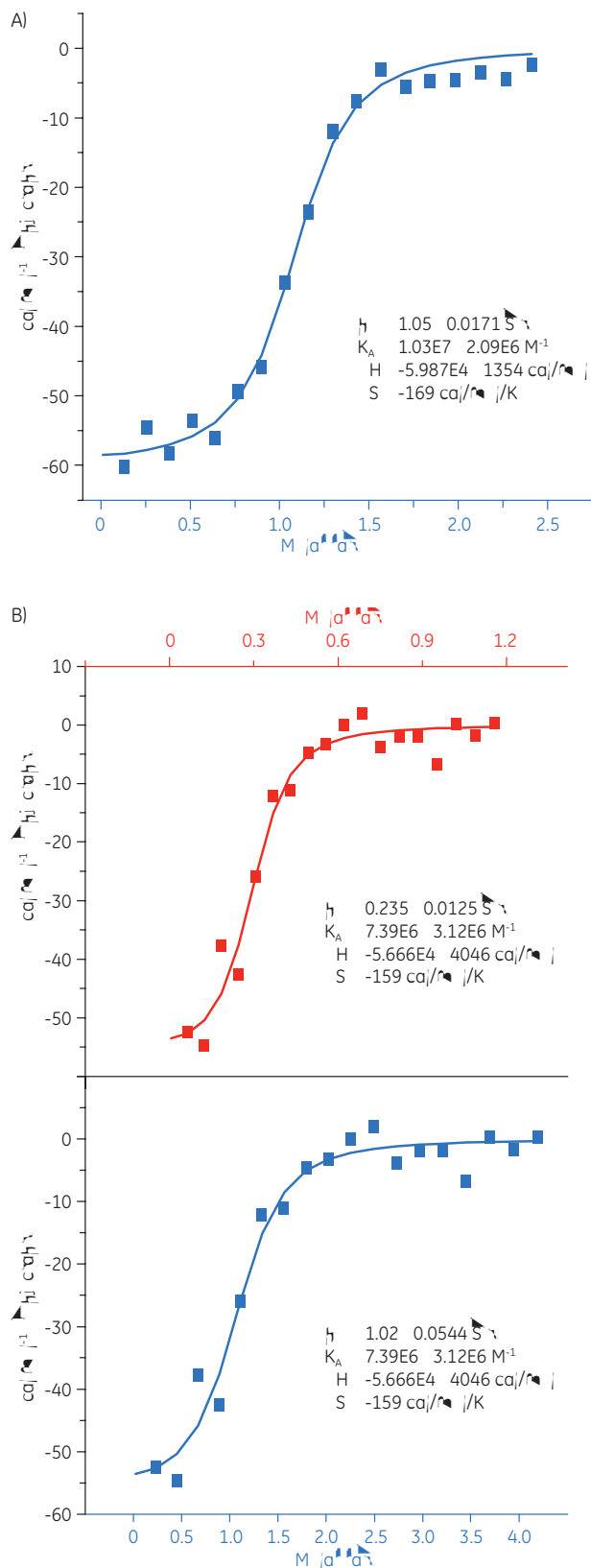

Fig 11. Two batches of target protein (A and B, respectively) titrated with a standard peptide. The sample cell contained the protein at a 10 μ M concentration, and the peptide solution was 50 μ M.

The result for Batch 1 (Fig 11 A) demonstrates a typical isotherm with a K_D of 97 nM and $n = 1$. The second batch (Fig 11 B) has a K_D of 135 nM but n is only 0.23. The analysis of the same set of data but with an estimated protein concentration of 2.3 μ M gives the same K_D value and $n = 1$. This indicates that 75% of the Batch 2 protein was inactive. The Batch 2 protein was rejected for use in the screening.

Acknowledgement

The data shown in Figs 5, 6, 9, and 10 were kindly provided by Dr. Lin Gao, Hoffman-La Roche, Nutley NJ, USA.

Technical specifications

MicroCal Auto-iTC₂₀₀ and MicroCal iTC₂₀₀

Sample volume	
MicroCal Auto-iTC ₂₀₀	370 μ L
MicroCal iTC ₂₀₀	280 μ L
Equilibration time from 25° to 5°C	< 6 min
Response time	10 s*
Throughput	
MicroCal Auto- iTC ₂₀₀	Up to 75 per 24 h (SIM)
MicroCal iTC ₂₀₀	8-12 per 8 h day
Injection syringe volume	40 μ L
Cell material	Hastelloy
Cell configuration	Coin-shaped
Cell volume	200 μ L
Noise	0.2 ncal/s†
Temperature range	2°C to 80°C
Temperature stability	150 μ cal at 25°C
Multiple feedback modes	Yes (passive, high gain, low gain)
Automated upgrade available	
MicroCal Auto- iTC ₂₀₀	NA
MicroCal iTC ₂₀₀	Yes
Weight	
MicroCal iTC ₂₀₀	9.4 kg
MicroCal Auto-iTC ₂₀₀	90.7 kg
Dimensions (W × H × D)	
MicroCal iTC ₂₀₀	21.0 × 33.7 × 34.9 cm
MicroCal Auto-iTC ₂₀₀	62.5 × 76.8 × 57.2 cm

* high feedback

† cell temperature = 25°C, no feedback, 5 s filter period, stir speed = 1000 rpm

Ordering information

Product	Code number
MicroCal iTC ₂₀₀ system, controller and software	28-4289-55
MicroCal Auto-iTC ₂₀₀ system, controller and software	28-4289-83
MicroCal iTC ₂₀₀ upgrade to MicroCal Auto-iTC ₂₀₀	28-4289-84

For local office contact information, visit
www.gelifesciences.com/contact

www.gelifesciences.com/microcal

GE Healthcare Bio-Sciences AB
Björkgatan 30
751 84 Uppsala
Sweden

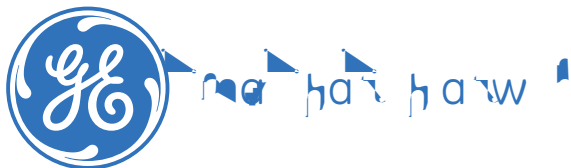

GE, imagination at work, and GE monogram are trademarks of General Electric Company.

Biacore and MicroCal are trademarks of GE Healthcare companies.

Hastelloy is a trademark of Haynes International, Inc.

Microsoft and Excel are trademarks of Microsoft Corporation.

Origin is a registered trademark of OriginLab Corporation.

© 2010–2011 General Electric Company — All rights reserved.

First published Apr. 2010

All goods and services are sold subject to the terms and conditions of sale of the company within GE Healthcare which supplies them.

A copy of these terms and conditions is available on request.

Contact your local GE Healthcare representative for the most current information.

GE Healthcare UK Limited
Amersham Place
Little Chalfont
Buckinghamshire, HP7 9NA
UK

GE Healthcare Europe, GmbH
Munzinger Strasse 5
D-79111 Freiburg
Germany

GE Healthcare Bio-Sciences Corp.
800 Centennial Avenue, P.O. Box 1327
Piscataway, NJ 08855-1327
USA

GE Healthcare Japan Corporation
Sanken Bldg., 3-25-1, Hyakunincho
Shinjuku-ku, Tokyo 169-0073
Japan